

INSTALLATION SHEET

RUGGED LINER

REAR INNER WHEEL WELL LINERS 19-21 GMC SHORT/STANDARD NEW BODY STYLE

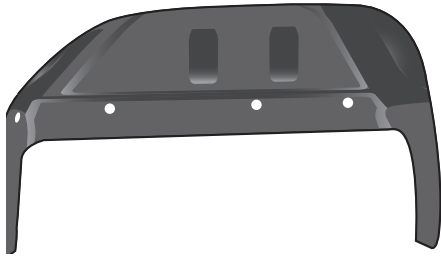

Driver Side Wheel Well (A)

LIST OF CONTENTS:

- (A) 1 - Driver Side Wheel Well
- (B) 1 - Passenger Side Wheel Well

LIK68 KIT:

- (C) 14 - Christmas Tree Fasteners
- (D) 14 - Rubber Washers

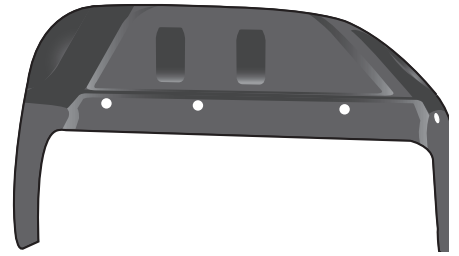
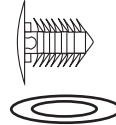

Passenger Side Wheel Well (B)

MISSING PARTS???

Call Rugged Liner at

800-433-3604

Any required parts will be shipped to you directly.

(DO NOT return whole kit to store)

TOOLS REQUIRED:

- T-10 Torx bit / driver used in step 3 and 9.

1

PLEASE READ INSTRUCTIONS CAREFULLY BEFORE STARTING THE INSTALLATION.
One person can perform the installation.



2

VEHICLE PREPARATION:

It is important that all areas where the wheel wells mount are clean and free of debris prior to installing.



3

Note: If your truck model came without the optional wheel well liners and fasteners please skip to step 4.

Note: If your truck model came with the optional wheel well liners and fasteners, remove the (7) factory fasteners using a T-10 Torx bit / driver holding the factory liners in place. **(Keep all factory fasteners).**

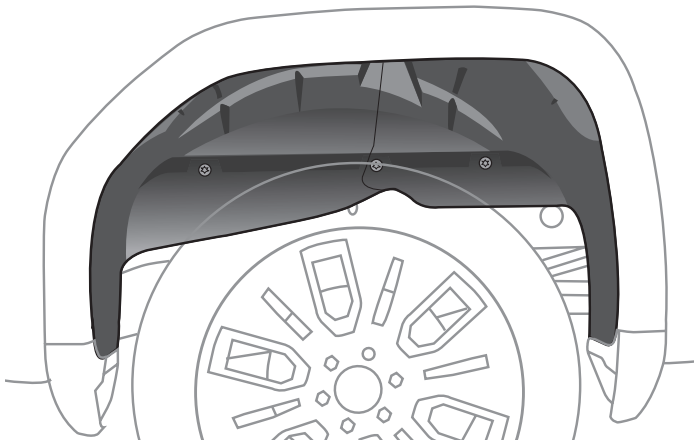

4

Start on the driver side by setting the driver side wheel well (A) marked as (DS) inside the inner panel of the truck's wheel well behind the tire.

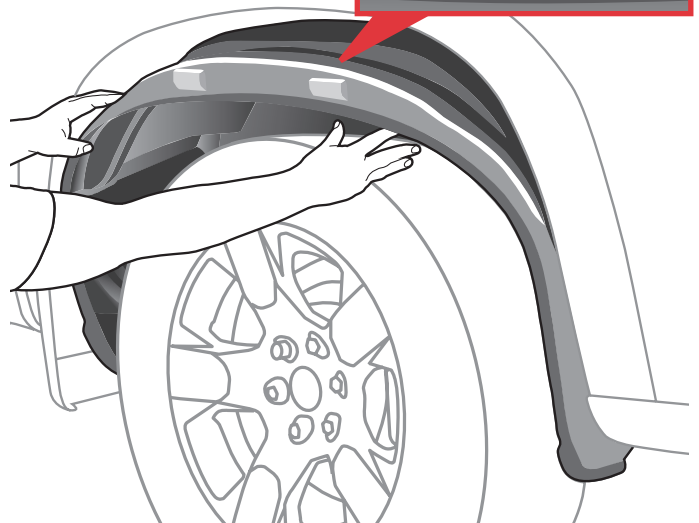

INSTALLATION SHEET

RUGGED LINER

19-21 GMC SHORT/STANDARD NEW BODY STYLE

- 5** Tuck the lower cab part of the wheel well liner behind the metal lip of truck's fender. Also tuck it behind the factory rock guard.

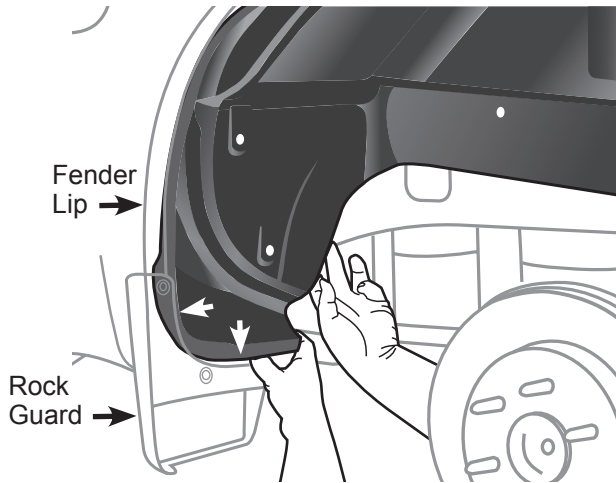

- 6** Tuck the lower tail part of the wheel well liner behind the metal lip of truck's fender. Also tuck it behind the factory rock guard.

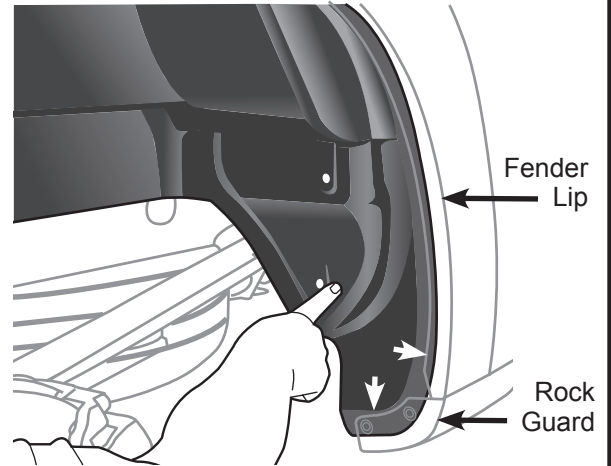

- 7** Tuck the upper part of the wheel well liner behind the rest of the metal lip of the truck's fender.

- 8** **Note:** If your truck model came **without** the optional wheel well liners and fasteners, use (7) of the Christmas tree fasteners (C) provided to install the liners.



OR

- 9** **Note:** If your truck model came **with** the optional wheel well liners and fasteners, re-install the (7) factory fasteners from step 3 along with (7) of the rubber washers (D) provided using a T-10 Torx bit / driver.

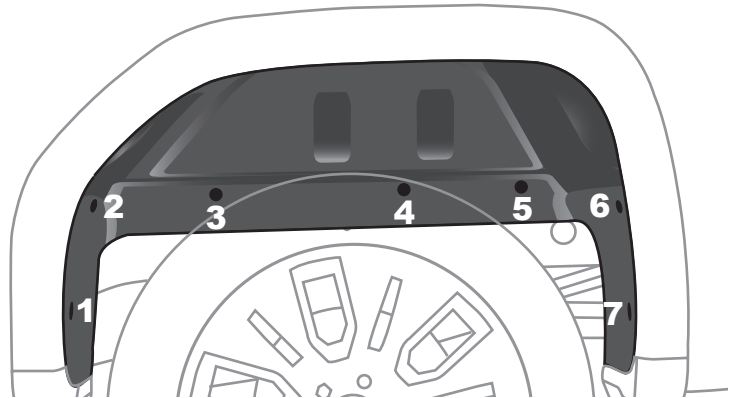
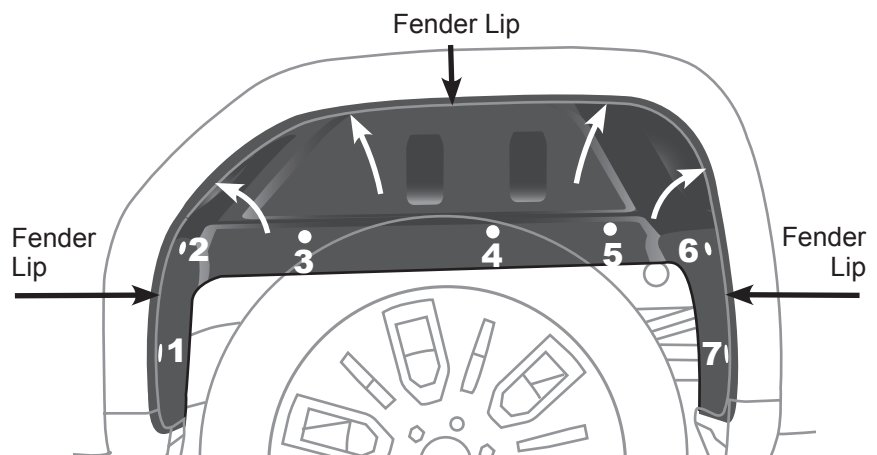

- 10** Repeat steps 3-9 on the passenger side when installing the passenger side wheel well (B).

